

# Checking fit of cabinets

## KITCHEN AND CABINET BATHROOM MAKING

**Supporting:**

***LMFKB3003A***

***Check and measure fit of cabinets***



## Learner guide

**Developed in 2011-2012 for the WELL Program**



---

# Checking fit of cabinets

## Learner Guide

This unit is also available in an e-learning format, which contains additional photos, interactive exercises and a voice-over narration of the text. It can be viewed on CD-ROM, or live on the web at:

<http://www.kbcabinetmaking.com.au/>



Developed by Workspace Training for the 2011-2012  
Workplace English Language and Literacy (WELL) Program  
Kitchen and Bathroom Cabinetmaking resource development project



[www.workspacelearning.com.au](http://www.workspacelearning.com.au)

---

ISBN: 978-0-9873328-7-5

Funded under the Workplace English Language and Literacy Program by the Australian Government through the Department of Education, Employment and Workplace Relations.

COPYRIGHT

© Commonwealth of Australia. 2012



**CC BY-NC-SA**

This work is copyright. Except where otherwise indicated, and save for the Commonwealth Coat of Arms, the Department has applied the Creative Commons Attribution-Noncommercial-Share Alike 3.0 Australia Licence to this work.

The Department of Education, Employment and Workplace Relations must be attributed as the author of the Department's copyright material.

As far as practicable, material for which the copyright is owned by a third party has been clearly labelled. The Department has made all reasonable efforts to ensure that this material has been reproduced in this print-based resource and the accompanying website with the full consent of the copyright owners.

Requests and enquiries concerning the Department's copyright material should be addressed to:

The Copyright Officer  
Department of Education, Employment and Workplace Relations  
Location code C148CW2  
GPO Box 9880 Canberra ACT 2601  
Email: [copyright@deewr.gov.au](mailto:copyright@deewr.gov.au)

Questions about the design and content of the resource itself should be addressed to the project manager:

David McElvenny  
Workspace Training  
PO Box 1954 Strawberry Hills, NSW, 2012  
Email: [david@workspacetraining.com.au](mailto:david@workspacetraining.com.au)

---

## About this resource

This learner guide is one of 11 learner guides developed for the *Kitchen and Bathroom Cabinetmaking* project, funded by the WELL Program in 2011-2012. The guides are aligned to the following core and elective competencies from the *Certificate III in Cabinetmaking (Kitchens and Bathrooms) LMF32109*:

<i>LMFKB2001A</i>	<i>Prepare for cabinet installation</i>
<i>LMFKB3001A</i>	<i>Identify processes in kitchen and bathroom</i>
<i>LMFKB3002A</i>	<i>Determine requirements for installation</i>
<i>LMFKB3003A</i>	<i>Check and measure fit of cabinets</i>
<i>LMFKB3004A</i>	<i>Conduct on-site adjustments to cabinets</i>
<i>LMFKB3005A</i>	<i>Fabricate cabinets for the built-in environment</i>
<i>LMFKB3006A</i>	<i>Install fitted cabinets and components</i>
<i>LMFFM3006B</i>	<i>Install furnishing products</i>
<i>MSAENV272B</i>	<i>Participate in environmentally sustainable work practices</i>
<i>MSAPMOHS200A</i>	<i>Work safely</i>
<i>MSAPMOPS101A</i>	<i>Make measurements</i>

The purpose of the guides is to help apprentice cabinetmakers acquire the background knowledge needed to satisfy the theoretical components of these units. However, they are not designed to replace the practical training necessary to develop the hands-on skills required. Learners will still need to receive extensive on-the-job training and supervision before they will be ready to be formally assessed in these units.

### E-learning version

All of these units are also available in an e-learning format, which contains additional photos, interactive exercises and a voice-over narration of the text. The e-learning version can be viewed live on the web at:

<http://www.kbcabinetmaking.com.au/>

The web version can also be purchased on a CD at a cost-recovery price from the project developer:

David McElvenny (project manager)  
Workspace Training  
PO Box 1954 Strawberry Hills, NSW, 2012  
Email: [david@workspacetraining.com.au](mailto:david@workspacetraining.com.au)

---

## Acknowledgements and disclaimer

### Project team

Project manager: David McElvenny

Instructional design: Kath Ware

Technical developer (website): Jim Vaughan

Assistant technical developer (and voice-over artist): Alex Vaughan

Quality assurance consultant: Giselle Mawer

Industry coordinator: Gary Dunshea (MSA Industry Skills Council)

Lead advisor: Rob Cole (Furnishing Industry Association of Australia)

### Technical Advisory Group

#### New South Wales

Brad Holmes – Hunter TAFE

Grant Cohen – Hunter TAFE

Dean Brakell – Furnishing Industry Association of Australia

Warren Peters – South West Sydney Institute of TAFE

Sean Greening – South West Sydney Institute of TAFE

#### ACT

Martin Jud – Canberra Institute of Technology

#### Victoria

Bryon Stanley – Furnishing Teacher's Advisory Group (VIC, SA, TAS)

Richard Brooks – Cabinet Makers Association

Simon Hampton – Wodonga TAFE

John Simpson – Holmesglen TAFE

#### Tasmania

Stephen Kirkman – Skills Institute Tasmania

#### Queensland

Rob McAdam – Skills TECH Australia

Brad Buhse – Skills TECH Australia

Roberto Viola – Gold Coast Institute of TAFE

#### South Australia

John Holst – Marleston TAFE

Dean Hart – Mt Gambier TAFE

Martin Videon – Furnishing Industry Association of Australia

---

## Northern Territory

Hermann Oltrop – Charles Darwin University

## Western Australia

Garry Michels – Polytechnic West

Keith Campbell – Polytechnic West

Adrian Boyling – Polytechnic West

David Boaden – Polytechnic West

Lorenzo Procopio – South West Institute of Technology

## National

Laurie Kruize – Housing Industry Association

## Photographs and graphics

All photos were taken by David McElvenny. All graphics were drawn by Kath Ware. We would like to thank the following companies for allowing us to take photos of their installers and workshop employees and generously providing technical advice:

Canobolas Kitchen Designs

Flair Kitchens

Danson's Kitchens and Joinery

Lamtex Innovative Furniture

Fewings Joinery

Stateline Cabinets

B&B Joinery

Ian McConnell Constructions

Krauss Kitchens

## Financial contributions

This resource was largely funded by the Workplace English Language and Literacy Program, through the Department of Education, Employment and Workplace Relations. However, due to the scale of the project and the provision of print-based and website resources, additional financial assistance was provided by the following organisations:

Manufacturing Skills Australia (Industry Skills Council)

Furnishing Industry Association of Australia



## Disclaimer

The content of this learner guide is provided for educational purposes only. No claim is made as to the accuracy or authenticity of the content. The views expressed in this publication do not necessarily represent the view of the Minister for Education or the Australian Government. The Australian Government does not give any warranty nor accept any liability in relation to the contents of this work.

---



---

## Table of contents

<b>Introduction</b> .....	<b>1</b>
<b>Section 1 Checking measurements</b> .....	<b>3</b>
Overview.....	5
Room dimensions.....	6
Plumb checks .....	8
Level checks.....	10
Templates.....	12
Service outlets .....	15
Recording details.....	17
Assignment 1 .....	19
<b>Section 2 Using measuring devices</b> .....	<b>21</b>
Overview.....	23
Conventional equipment .....	24
Electronic equipment .....	26
Assignment 2 .....	28
<b>Practical demonstration</b> .....	<b>30</b>

---

## Introduction

In the workshop, cabinets are always manufactured 'square and true', with 90 degree corners and straight, parallel sides. But that doesn't mean that when you get to the jobsite the floors and walls will be the same!

Buildings are never perfect, because there are so many materials and components that go into the structure, and lots of people involved in constructing them. In older buildings the variations may be more exaggerated, because some parts are likely to have 'settled' more than others over the years, resulting in deviations in floor levels and wall angles.



In this unit, we'll examine the sorts of on-site measurements and levels you need to check before installing pre-fabricated cabinets, so that you can make any last-minute adjustments required to achieve a good fit. We'll also cover the main pieces of equipment that installers use when checking measurements and levels.

### Preparing for this unit

There are no formal prerequisites for this unit. However, you will find it easier to undertake the assignments and practical demonstrations required if you have already completed the following units from this series of learner guides:

- *Making measurements*
- *Installation requirements.*

You should also revise the safety aspects of working on-site from the two units shown below:

- *Working safely*
- *Preparing for installation.*

### Working through the unit

There are two sections in this unit:

- Checking measurements
- Using measuring devices.

Each section contains an *Overview*, an *Assignment*, and *Lessons* which cover the content material. Your trainer may ask you to submit the assignments as part of your assessment evidence for the unit. You will find hard-copy templates for these assignments in the separate Workbook.

Electronic 'Word' templates of the assignments are available on the website for this resource, at: <http://www.kbcabinetmaking.com.au/>

The electronic versions can be completed on-screen and sent to the trainer either as:

- a printed hard copy, mailed through the post
- an electronic file, emailed as an attachment.

## **Practical demonstration**

Your final assessment of competency in this unit will include various practical demonstrations. Their purpose is to assess your ability to put your knowledge into practice and physically carry out the process of checking measurements and other details prior to installing cabinets. To help you get ready for these activities, there is a *Practical demonstration* checklist at the back of this Learner guide.

The checklist sets out the sorts of things your trainer will be looking for when you undertake the practical demonstrations. Make sure you talk to your trainer or supervisor about any of the details that you don't understand, or aren't ready to demonstrate, before the assessment event is organised. This will give you time to get the hang of the tasks you will need to perform, so that you'll feel more confident when the time comes to be assessed.

Section 1

# Checking measurements





## Overview

It's the sign of a professional installer to be able to cope with all the deviations in the walls and floor of a room, while still producing a completed installation that has level surfaces, doors that hang plumb, gaps that are even, and everything properly aligned.

But in order to achieve this, you need to know exactly where the variations are so that you can make allowances for them. This includes checking lengths and heights, squareness of corners, levels of floors and vertical alignment of walls.



The more accurately you can measure these variables, the better the finished job will be once the units have been fitted.

In this section, we'll talk about the types of measurement and level checks you need to make so that you know which sorts of adjustments to carry out before fixing the cabinets are fixed in position. We'll also discuss some of the techniques used by installers to fit cabinets against walls that are out of plumb or have deviations in their surface.

### Completing this section



The assignment for this section is designed to test your understanding of basic calculations and your ability to record measurements and other important details in a freehand sketch. Have a look at *Assignment 1* on page 19 to see what you'll need to do to complete it.

There are also six lessons in this section:

- *Room dimensions*
- *Plumb checks*
- *Level checks*
- *Templates*
- *Service outlets*
- *Recording details*

## Room dimensions

Rooms should be checked for square and measured from wall to wall and floor to ceiling. Any other features in the room, such as doorways, windows, built-in pantries or structural elements that will affect your work should also be measured.

The best way to record measurements is to sketch a floor plan and elevations of the room and mark in the measurements as you go. We discussed the process of sketching a floor plan and elevations in the unit: *Installation requirements*.

Go back to that unit now if you need to revise the symbols used in floor plans or the details of how to go about producing a quick sketch on-site.

### Wall to wall measurements

Wall to wall measurements should be taken at the top, middle and bottom of the walls. Don't forget to mark in the thickness of skirting boards if they've already been fitted.

Do this in two separate positions, so you can be confident you've allowed for the possibility that the walls aren't running parallel to each other.

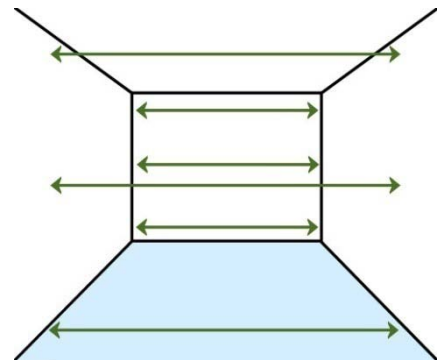

### Floor to ceiling measurements

Floor to ceiling measurements should be taken at each end of the wall, and also in the middle if it's a long wall.

Again, measurements should be taken in two separate positions. This will help you to pick up variations in floor or ceiling levels.

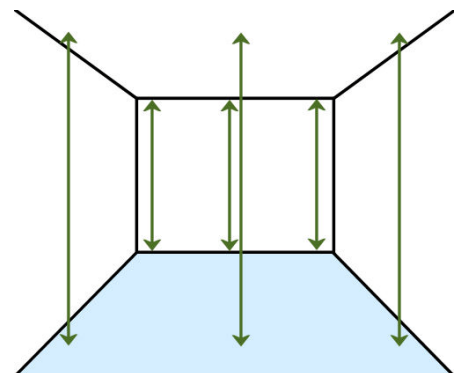

### Doors, windows and other features

Doors, windows, columns and other features that will have an effect on your installation should be marked on an elevation of that wall. Depending on the wall, you might also need to include the positions of power points, plumbing outlets, phone sockets, air conditioning vents and other services.

We'll look at these in more detail in the lesson: *Service outlets*.



## Checking for square

An angle is **square** if it is at 90 degrees – in other words, a **right angle**. When a room is square, its opposite walls are parallel to each other, and the corners are all at 90 degrees.

Note that saying a room is 'square' is not the same thing as saying it is 'a square'. You'll remember from your school days that a square has 4 equal sides. But in building terms, any rectangular room is 'square' when its walls meet at 90 degrees.

To check a rectangular room for square, all you need to do is measure the diagonals. If they're not the same, then the room isn't square.

If the room is open and doesn't have 4 corners, you can still check an angle for square by using the **3, 4, 5 method**.

Measure 3 units along one wall and mark the point, and 4 units along the other wall and mark the point. The distance between the two points should be 5 units.

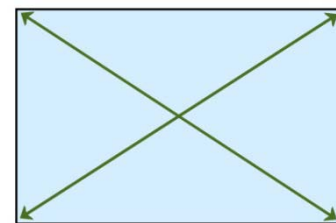
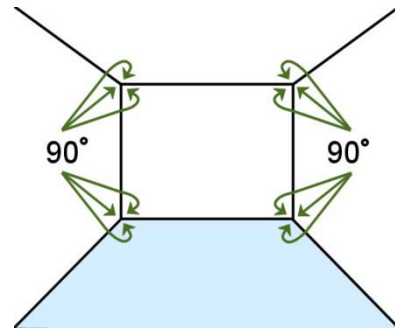

Plan view

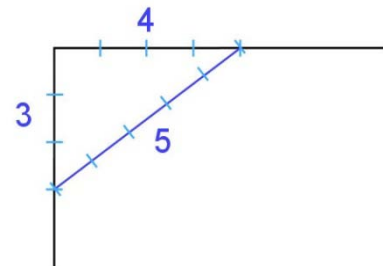

## Learning activity



Try the 3, 4, 5 method for yourself to prove that it works. Get a tape measure, find a right angled corner that you know is square, and take the three measurements. Note that a 'unit' can be anything you like, as long as it's the same for all three sides of the triangle. So your measurements could be 3 m - 4 m - 5 m, or 300 mm - 400 mm - 500 mm, or 600 mm - 800 mm - 1000 mm, or another other multiple of 3 - 4 - 5.

You'll see a full explanation of this technique in the unit: *Making measurements*.

## Plumb checks

**Plumb** means perfectly vertical. It comes from the Latin word for lead, because plumb bobs were originally made from lead. When a plumb bob is hung from a string, gravity draws the weight downwards, and the string forms a vertical line.

Before people started using spirit levels, a plumb bob was the most reliable way of checking that a wall was vertical. They are still sometimes used to line up a vertical point over a mark, such as a surveying instrument or staircase post.



### Checking walls

The easiest way to check walls for plumb is to put a **spirit level** on the wall. If the bubble is not in the centre of the vial, you'll need to find out how far out of plumb the wall is by moving either the top or bottom of the level away from the wall until the bubble finds centre. Then measure the gap between the level and the wall.

Note that you only need to measure the gap at the height you're working to. That is, if the cabinet height is 870 mm above the floor, that will be the point where you should take the measurement.

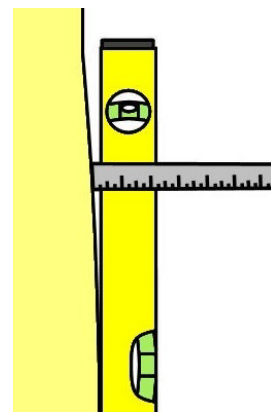

When it comes to installing the cabinets, the gap can be wedged or packed, and a filler piece inserted between the cabinet and wall. We'll talk more about this in the units *Adjusting cabinets on-site* and *Installing cabinets on-site*.

### Using a level with a straight edge

Spirit levels come in lengths ranging from pocket sized mini levels through to builders' levels 1800 mm long or more. The longer the level is, the more accurate your measurements will be. However, a long level isn't much good if you can't fit it into the space you're working in.

Most kitchen and bathroom installers carry a short level for cramped spaces and a 1200 mm level for general use. If they need to check a level over a long distance, they use a straight edge and sit the level on top.

You can buy a straight edge made from aluminium. Alternatively, you can use a board that's perfectly straight, such as a kickboard or long strip of plywood. Obviously, a straight edge needs to be perfectly straight to get a true reading, so if you're using a re-sawn board you should sight along its length to check that there's no hollows or high spots.



### ***Learning activity***



Have a go yourself at checking walls for plumb and looking for deviations in the flatness of the wall. It's best to use a 1200 mm level. Sit one end on the skirting board and take a reading at the top end. If the bubble isn't exactly in the centre of the vial, move the level until it is. Then measure the gap between the level and the wall.

Take several readings at different heights on the wall. Also look for any hollows in the wall while you're holding the level in place.

## Level checks

**Level** means perfectly horizontal, which is 90 degrees to a plumb line.

Kitchen floors can be out of level if the building's footings or framing have settled unevenly, or if there are problems in the subfloor materials or workmanship.

Bathrooms always have an inbuilt fall towards the floor waste pipe to allow splashed water to drain quickly. So you have to find the highest point in the floor, and use that as your starting point.



But before you check the levels, you need to know whether there is a specified height for the bench tops. The finished height may have been specified to match existing units or fit under a window sill or other feature. Once you know the height you're working to, subtract the thickness of the bench top and then draw a horizontal line around the room where the cabinets will go. This will be the finishing height of the carcasses.

Some installers use a spirit level to draw the level line. Others use a laser level to 'shoot' lines around the walls. When this reference line is in position, you can measure down to the floor at various points and establish where the high spots are.

If a finished bench top height wasn't specified, you can simply work from the floor up. However, you still need to think about the finished height, because if there's a significant fall in the floor, you might end up with a bench top that's too high at the low end.

For example, if you started with a height of 900 mm at the high end, and the overall fall was 60 mm, the bench top would be 960 mm above the floor at the low end. This is too much.

To fix this problem, you should take an average height, say 900 mm, and balance the high and low points either side. So your bench top in the example above would run from 870 mm where the floor is at its highest to 930 mm where the floor is lowest.

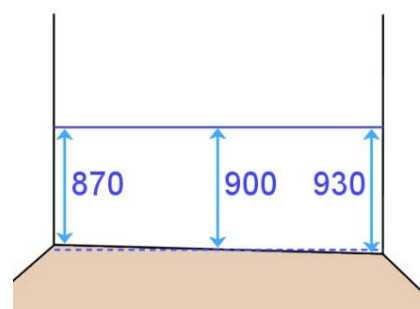
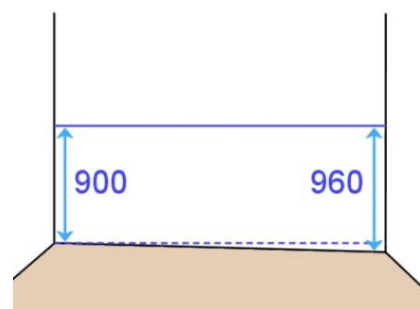

When you install the **plinth** (base framework), you'll need to accommodate the fall in the floor by either planing the material, packing under it, or both. In some cases, the cabinets themselves can also be levelled with adjustable feet.

We'll talk more about these techniques in the units *Adjusting cabinets on-site* and *Installing cabinets on-site*.



### Learning activity



Use your spirit level to check the floor levels in the building you're in. Look for the high and low spots by checking levels in various places.

A 1200 mm level is best for this task. If the bubble is not in the centre of the vial, lift the level at one end until the bubble centres, and then put a packing piece in the gap to keep it level. Measure the gap with a tape measure or steel rule.

See if you can calculate the difference between the highest and lowest points by adding up the discrepancies.

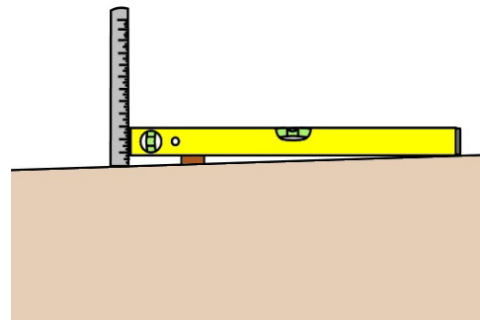

## Templates

The purpose of a template is to provide a pattern or shape that can be traced onto the material that needs to be cut. If it turns out that the walls are not square, or that there are unusual angles between walls, you may need to make up a **template** to record the angle or shape.

A template can also be used to **scribe** the deviations in a wall that isn't flat. Depending on the size of the template you're making, you can use cardboard, plywood, MDF (medium density fibreboard), thin timber or other suitable board products.



### Recording angles with a template

To make a large template, it's best to use plywood or another board product about 10 mm thick. Cut the board to the lengths of the walls that form part of the job. Then put the boards in position against the walls and screw them together where they overlap.

Make sure that the template is held at the correct height for the work it's intended for. For example, if the template is being used to get bench top angles, you will need to fit the template at exactly that height.

If you need to take a large template back to the workshop, you can unscrew the boards and dismantle them so they'll fit easily in your vehicle.

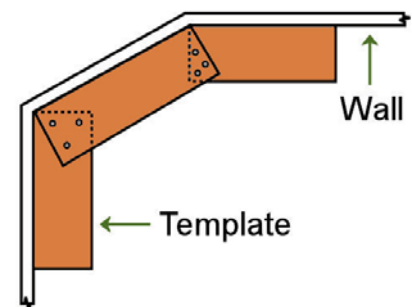

### Scribing deviations in a wall

There will be times when you'll need to cut a **filler piece** or **end panel** to cover a gap between the wall and a cabinet. If the wall isn't flat, you can make up a template to the exact shape of the wall, and then transfer the line across to the filler piece or end panel. You can also use this technique to shape

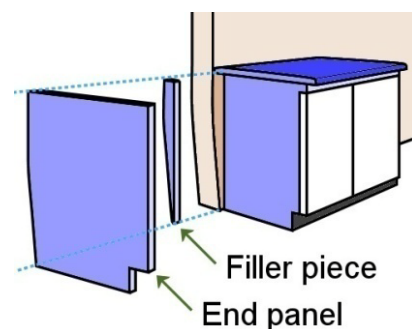



a bench top to fit exactly against the wall.

Hold the template in place and scribe the line with a pencil. Some installers use a small block of wood to guide the pencil, and slide the block along the wall to follow the contours. Other installers use a compass, with the point following the line of the wall. You can also buy scribing tools to do the same job.

Cut the template to the line using the most appropriate tool. If your template is made from timber or sheet material, you might use a plane or jig saw. If it's cardboard you can simply use a Stanley knife.

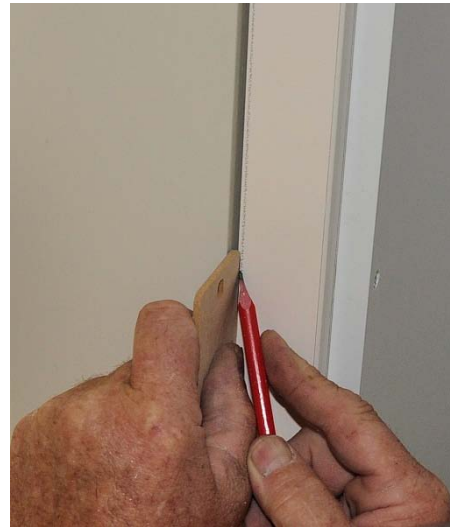

When you're happy with the fit, put the template onto the finishing piece and transfer the line across with a pencil. Cut the piece to the line, being careful not to chip the finished surface. We'll talk more about the techniques and precautions you should take in this process in the unit: *Adjusting cabinets on-site*.

### Learning activity



If you haven't been involved in scribing a template before, have a go now by following the steps below. Let's say you need to cut an end panel for a cabinet and it requires a template to get a tight fit to the wall. You can work from the top of the skirting board if you wish, or work from the floor and incorporate the profile of the skirting into the template.

1. **Find a wall with deviations in it.** Use your level as a straight edge, or a piece of kickboard or other board with a true edge. Hold it against the wall and look for gaps. Check several walls and choose the one with the worst deviation.
2. **Cut the template material to length.** Use cardboard, plywood or some other thin board and cut it to the correct length – say 870 mm if you are working from the floor to the underside of a bench top.
3. **Scribe the wall contours with a pencil.** Use a block of wood to guide your pencil line. Choose a block that's slightly thicker than the widest point in the gap that you're scribing.

4. **Shape the template to the pencil line.** If your template is made of cardboard, you can simply use a Stanley knife. If you're using a board product, you might be able to shape it with a coping saw or hand plane.

If it turns out that you need to use a power tool, make sure you secure the template properly and follow all required safety procedures. Talk to your trainer or supervisor about methods for securing narrow boards to a saw stool or work bench if you're unsure.

5. **Test the template against the wall.** Hold the template in place and check for gaps. Mark any high spots with a pencil and reshape the line until you're happy that the fit is close enough. Try to get a maximum gap of 1 to 2 mm at the worst points.



## Service outlets

Some cabinets will require cut-outs in the back, side or base panels before they're installed. These cut-outs will allow pipes and cables to come through for services such as water, power and gas.

The outlets and pipes should already be in place by the time you're carrying out the final checks. Power points and switches may have been fitted to electrical cables, or the wires may be protruding from the wall, depending on the stage of the job and whether it's a new project or a renovation.

One way of recording the locations of service outlets is to draw layout lines on the walls where the cabinets will go, and then take measurements in relation to the cabinets that will contain those services. Here's an example of how to go about it, and what the measurements might look like.



### Step 1: Mark the cabinet carcase height

Let's say the finished bench top height is 900 mm above the floor, and the bench top thickness is 32 mm. This means that the cabinet carcases will finish at a height of 868 mm. Draw a level line along the wall wherever the base cabinets will be at that height.

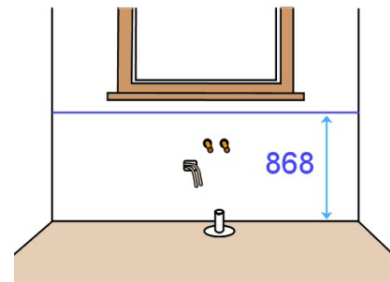

### Step 2: Mark the cabinet sides

Use your floor plan to take off the cabinet widths, and mark the plumb lines down the wall, between the level line and the floor. Make sure you build in the correct allowances at the ends for walls that are out of plumb and any filler pieces that might be required, because this will affect the positioning of the cabinets.

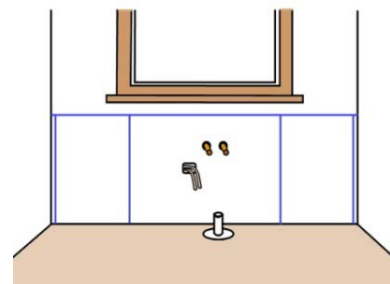

### Step 3: Measure the positions of service outlets

Use the markings for the cabinet that will contain the services, and measure in from one side and down from the height line to locate the water pipes, electrical wires and other services. When you transfer the measurements to the actual cabinet, you should measure down from the top and across from the side to mark the positions of your holes or cut-outs.

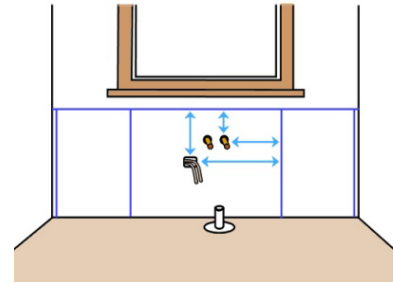

Remember, though, that when you're looking at the back of the cabinet it will be a mirror image of the wall. Don't make the mistake of marking up the cabinet back-to-front!

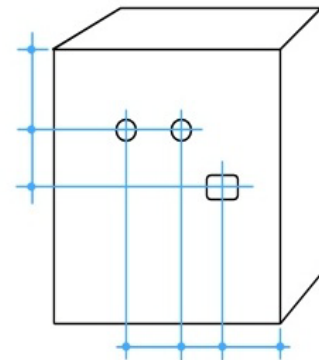

### Learning activity



The Australian Standard for *Domestic kitchen assemblies* contains specifications for the preferred locations of cut-outs for power points, dishwasher connections, vents and ducts, as well as other layout dimensions relating to range hoods, cook tops, splash backs and so on. These are set out in AS/NZS (Australian Standard / new Zealand Standard) 4386.2 under the heading: *Appendix A: Coordination of service zones*.

Ask your supervisor or trainer if you can borrow the Standard to have a look at the diagrams and specifications. You don't need to memorise them, but it's very useful to know the general principles relating to these dimensions and clearances.

## Recording details

When you're taking measurements, checking levels and looking at design features, you need to be able to write down the details quickly and precisely. This lets you refer to your measurements later without getting confused about what the numbers meant, or whether you had made allowance for all of the things that needed to be considered.

The best way to record measurements and construction features is to draw a quick sketch showing all the important details. Then you can mark in the specific dimensions, variations in levels, adjustments required, and any other aspects of the job that are relevant to the installation process.

A written record of your measurements also lets you give clear directions to your offside about what you want them to do, particularly when you're asking them to cut or shape particular pieces.

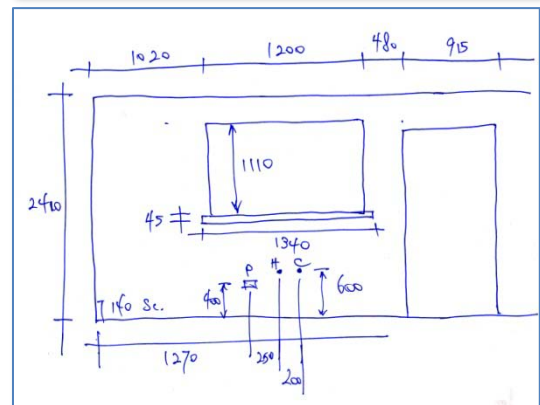
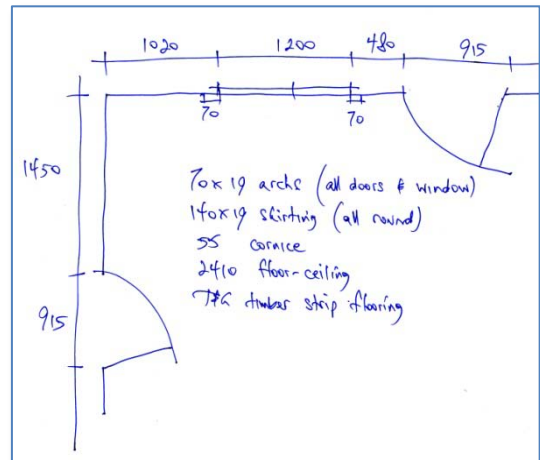

We talked about the process of sketching quick floor plans and elevations in the unit: *Installation requirements*. You should revise that unit now if you're unsure of how to go about it, or want to refresh your memory on the symbols and drawing conventions commonly used.

In practice, there are no hard and fast rules on how to draw an on-site sketch. If it makes sense and everyone who needs to follow it can understand the details, then it's doing all it needs to do. However, all professional installers tend to use the same basic architectural conventions when they draw plans and elevations. The reason is that they work well, and are easy to follow for everyone who needs to refer to the drawings.

Your company or supervisor may also have particular ways of showing certain details that suit the specific types of installations you carry out and the processes and materials you use.

## Learning activity



You may already be familiar with the sorts of site sketches that are drawn by installers at your company. You may even be producing on-site line drawings yourself.

If not, ask your boss or supervisor if you can have a look at some of the sketches produced by the installers. Look closely at the abbreviations, symbols and other drawing conventions used. If there are things you don't understand or aren't sure about, ask your supervisor to explain them to you.

## Assignment 1

### Task 1

Drawing 1 below shows a wall in a kitchen, with hot and cold water pipes and power for the dishwasher power point. The cabinet installer has measured where the services are in terms of the left hand wall and the finishing line (top) of the cabinet carcasses. Drawing 2 shows the layout lines for the cabinets, together with their names and width dimensions. Drawing 3 (next page) shows the sink cabinet, viewed from the back.

Work out where the centre points will be for the three holes in the back of the cabinet. Write your answers in the boxes provided on Drawing 3 in the Workbook for this unit.

#### Drawing 1

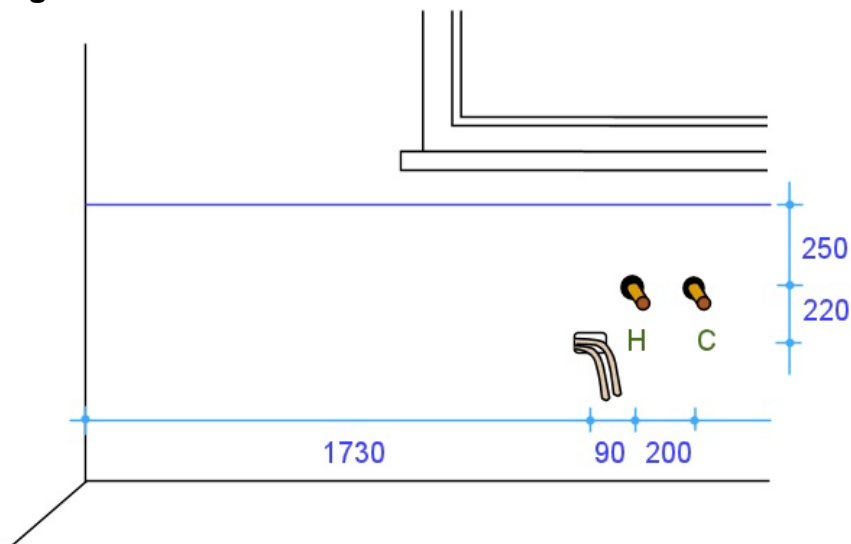

#### Drawing 2

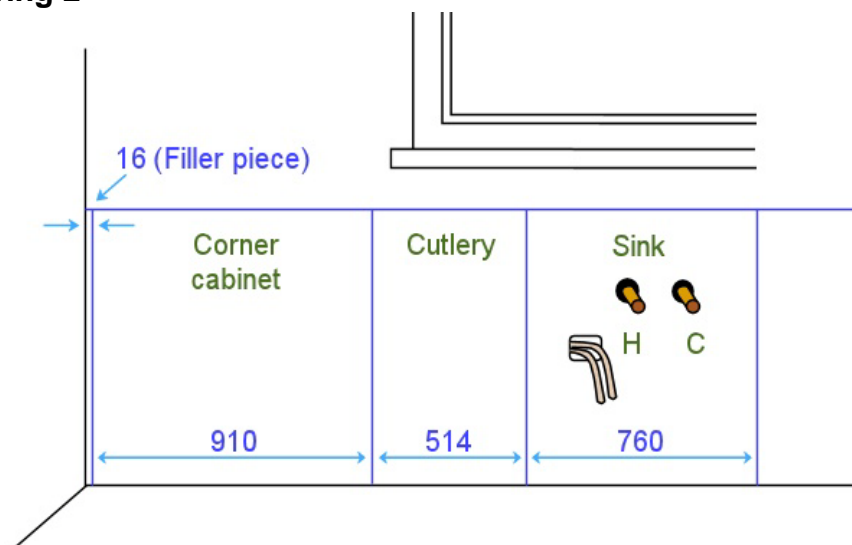

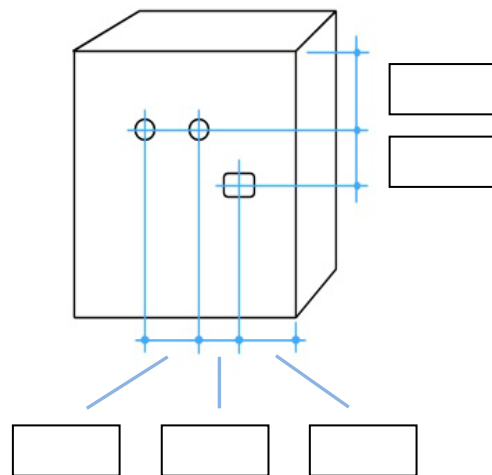
**Drawing 3**

Note that the positions of these holes are reversed in relation to the view of the wall, because you are looking at the back of the cabinet.

**Task 2**

Assume that you have been asked to check all relevant measurements on one wall of a kitchen or bathroom, in preparation for a new installation. Your task is to produce a freehand sketch of that wall in elevation view, showing all required features and measurements.

The wall you choose to draw up may be in a building where you are installing a kitchen or bathroom. Or it may be in your own home or a friend's home, if you don't have access to a jobsite. Do not show any existing cabinets or other fittings – you should assume that these will be demolished before the new installation begins.

The wall should include the following features as a minimum: a door, a window and water pipes for taps. It may also include other features, such as power outlets, columns, bulkheads and any other architectural features.

You may use symbols and abbreviations in your elevation sketch, but all details must be clear to others who might need to consult the drawing, and all relevant measurements must be easily identifiable.

**Completing this assignment**

You will find a hard-copy page for this assignment in your Workbook. There is also an electronic version of the page on the website. See the *Introduction* for more details on how to access this 'Word' file (page 1).

Section 2

Using  
measuring  
devices







## Overview

Most kitchen and bathroom installers work with conventional measuring devices that have been used in the building industry for many years. These include tape measures, squares and spirit levels.

In recent years a wide range of electronic instruments and attachments have become available, such as laser levels, electronic angle finders and digital distance measurers.

If you have already completed the unit *Make measurements*, you will have covered the concepts of measuring lengths, angles and levels. You will also have looked at the different units of measurement in the metric system and techniques for reading and recording measurements taken in millimetres.



This background will help you to understand the topics we'll cover in this section.

### Completing this section



The assignment for this section is designed to test your understanding of measuring tools and techniques. Have a look at *Assignment 2* on page 28 to see what you'll need to do to complete it.

There are also two lessons in this section:

- *Conventional equipment*
- *Electronic equipment.*

These lessons will provide you with background information relevant to the unit of competency.

## Conventional equipment

Set out below are some conventional measuring tools that don't require electronic circuitry to operate.

### Tape measure

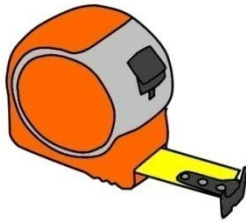

The tape measures used by kitchen and bathroom installers are generally 7 to 8 metres long with a retractable steel blade.

The blade has a steel hook on the end secured with rivets, with a bit of play in the holes allowing the hook to move back and forth. The amount of movement allowed is the same as the thickness of the hook. The purpose of this movement is to compensate for the hook thickness when you either push the tape up against an object for an inside measurement, or hook it over the object for an outside measurement.

### Squares and bevels

There is a wide variety of squares, bevels and other angle-checking tools. The most common types used by on-site installers are as follows.

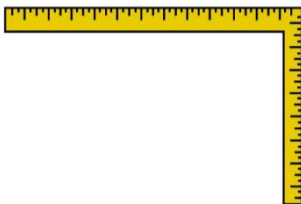

**Carpenter's square**, also called a framing square, because it is sometimes used to set out angles on framing timbers.

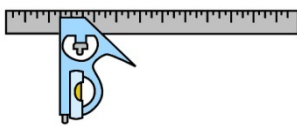

**Combination square**, which allows you to set out  $90^{\circ}$  and  $45^{\circ}$  angles.

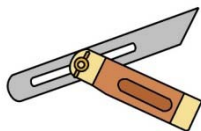

**Bevel**, which lets you set any angle you like.

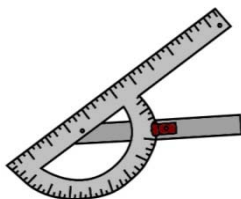

**Protractor**, which is like a bevel but has the degrees marked in an arc.

## Spirit level

Spirit levels come in many sizes, shapes and lengths. What they all have in common is that they have a vial, or tube, that contains a bubble floating in fluid. The level works on the principle that the bubble will find the highest point in the tube, because it is lighter than the surrounding fluid. Since the tube is curved slightly with the highest point in the middle, the bubble floats exactly in the middle when the level is horizontal.

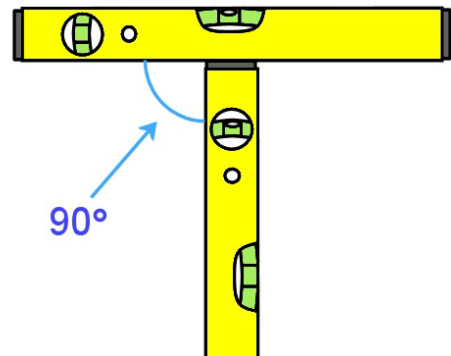

The spirit levels used by installers generally have a vial in the centre to check for level and another vial in the end to check for plumb. The vials themselves are exactly the same, but are mounted at 90 degrees to each other.

## Water level

The principle of the water level has been around for thousands of years. Many bricklayers and stone masons still use water levels, but they are not so common with kitchen and bathroom installers. Nonetheless, they are useful when you need to transfer a level mark from one point to another point some distance away.

You can make a water level simply by getting a clear plastic hose and filling it almost to the top with water. Some people add food colouring to the water to make it easier to see.

To use the level, put one end at the height you want to match, and the other end at the point where you want to transfer the line. When the water in the tube settles, the heights at both ends will be exactly level.

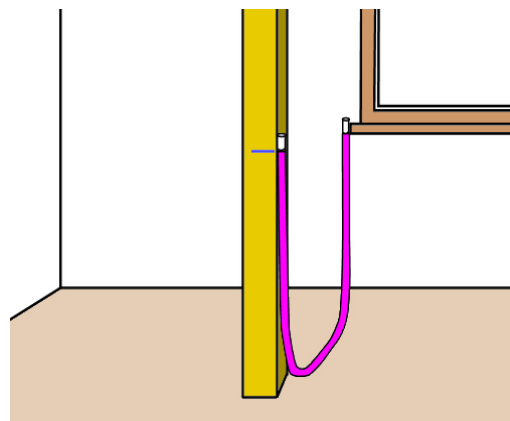

## Learning activity



What devices do you use on-site for checking lengths, angles and levels? At this stage, don't include the electronic tools you use, because we'll talk about them in the next lesson.

Share your answers with your trainer and other learners in your group. If you are studying this unit remotely, you might want to take digital photos of the devices and send them through with your descriptions.

## Electronic equipment

There is an ever-increasing range of electronic measuring and levelling equipment available to kitchen and bathroom installers. Although they are not essential to the job, some of these devices are becoming quite popular as their prices continue to fall and their operation becomes more user-friendly.

Below is a brief summary of the main items.



### Laser level

Laser levels range from dot lasers to multi-function rotary lasers. The main types are shown below. On the more expensive models these functions can be combined in a single unit.

- **Plumb or dot laser** – emits single dots on the wall at level points and plumb points
- **Line laser** – emits a single level or plumb line on a wall
- **Rotary laser** – emits a level or plumb line around 360 degrees.

Some installers use a laser level when they begin the set-out and marking process in preparation for an installation. Others prefer to use the laser level simply to check their levels while the cabinets are going into place.

### Electronic angle finder

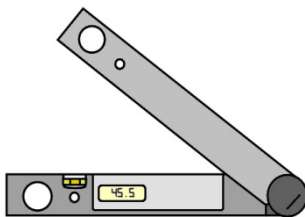

These are also called 'digital angle finders', and allow the user to measure precise angles and transfer them to other surfaces or positions. They are particularly useful when working around staircases, sloping ceilings and unusually-angled walls.



### Electronic length measurer

These are sometimes called 'laser distance measuring devices', or 'digital distance measurers'. They often have built-in mini-computers that can calculate areas, volumes and angles based on the distance measurements taken.

## Learning activity



The devices described above are just some of the digital measuring tools available. Others include clip-on digital levels (that attach to your existing level) and 'smart' tools that beep when they find the level or angle you've specified.

What electronic devices do you use on-the-job? Write down their names and a brief description of what they do.

Share your answers with your trainer and other learners in your group. If you are studying this unit remotely, you might want to take digital photos of the devices and send them through with your descriptions.

## Assignment 2

### Question 1

You need to measure the width of a room with your tape measure. So you ask your offsider to hold the end of the tape against one wall while you stretch out the tape to the opposite wall.

However, you notice that there is a sag in the tape, because you're both working at waist height and it is a long room.

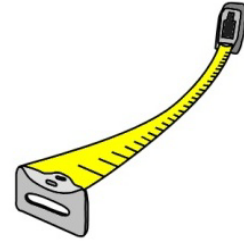

- (a) What effect will the sag in the tape have on the measurement?
- (b) How can you overcome this problem?

### Question 2

At one end of the room there is a boxed-in section which houses a waste pipe. You need to measure the full length of the room, so your offsider holds the tape beside the boxed-in section while you stretch it across to the far corner.

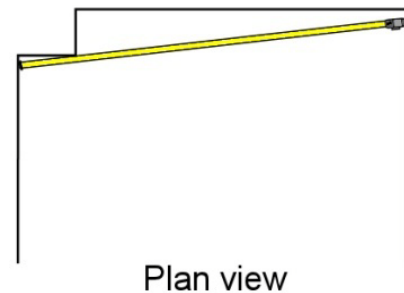

But when you look back you can see that the tape is not running at right angles to the two walls.

- (a) What effect will this angle have on the measurement?
- (b) State two different ways you could overcome this problem by repositioning the tape. (Hint: one way will occur at your end, and the other way will occur at your off-sider's end.)

### Question 3

You have been given an old spirit level that looks a bit knocked around. You place it on the floor and find that the bubble is exactly in the middle of the vial, indicating that the floor is dead level.

But when you turn the level back-to-front and check it again, the bubble is now off centre.

- (a) Is this level giving you accurate readings?
- (b) What should you do with the level?

#### **Question 4**

What is the commonsense safety precaution to keep in mind when working with a laser level? (Hint: it concerns your eyes.)

---

#### **Completing this assignment**

You will find a hard-copy answer sheet for this assignment in your Workbook. There is also an electronic version of the answer sheet on the website. See the *Introduction* for more details on how to access this 'Word' file (page 1).

---

---

## Practical demonstration

The checklist below sets out the sorts of things your trainer will be looking for when you undertake the practical demonstrations for this unit. Make sure you talk to your trainer or supervisor about any of the details that you don't understand, or aren't ready to demonstrate, before the assessment event is organised. This will give you time to get the hang of the tasks you will need to perform, so that you'll feel more confident when the time comes to be assessed.

When you are able to tick all of the YES boxes below you will be ready to carry out the practical demonstration component of this unit.

---

### Practical demonstration checklist

You will be asked to check and measure the fit of cabinets in a range of situations. Your trainer will need to see you carry out these activities over a period of time, to make sure that you are satisfying these 'demonstration criteria' consistently under different conditions.

Demonstration criteria	YES
1. Follows all company safety policies and procedures while at work and any additional site-specific policies while at the jobsite.	<input type="checkbox"/>
2. Selects the correct tools and equipment for the work to be undertaken and checks that they are in good working order.	<input type="checkbox"/>
3. Uses measuring devices correctly and in accordance with manufacturer's instructions	<input type="checkbox"/>
4. Identifies all structural details and other features that will impact on the installation process and records the measurements clearly and accurately.	<input type="checkbox"/>
5. Checks floors for level and walls for plumb using a spirit level, and correctly records any deviations	<input type="checkbox"/>
6. Identifies variations in squareness or trueness of walls and floors and makes appropriate decisions on how to allow for them	<input type="checkbox"/>
7. Reads construction plans correctly and translates information to the site layout and physical cabinet dimensions	<input type="checkbox"/>



- 8. Calculates adjustments required to cabinets and marks them accordingly
- 9. Completes all required documentation